



Vulcan 500c

Vulcan 500c

Vulcan 1200e

Vulcan 1600e

The Compact Laser Cleaning Solution

The Vulcan 500c system is a 500W pulsed fiber laser, paired with a robust galvanometer based, ergonomic hand-held, compact scan head. With flexible operational parameters, fiber laser reliability and high pulse energy, Vulcan 500c offers the best value in laser cleaning. The unique hand-held galvanometer based scan head is an integral part of the package. The Vulcan 500c offers state of the art universal control systems and simple synchronization that will deliver faster processing and unlock the highest potential of laser based paint and coating removal and surface preparation.



Features

- 500W Compact Cleaning System
- Pulse Energy Up To 40 mJ
- Simple Touchscreen User Interface
- Optional Integrated Fume Extractor
- Adjustable Scan Speed and Scan Width
- Replaceable Cover Window
- Edge Blanking
- 220 V Single Phase

Applications

- Paint and Coating Removal
- Rust Removal
- Surface Activation
- Oxidation Removal
- Pre-Weld Preparation
- Surface Cleaning and Restoration
- Mold Cleaning



Typical Laser Performance

Vulcan 500c

Vulcan 1200e

Vulcan 1600e

Average Power (W)	500
Pulse Duration (ns)	Approx. 50 ns
Pulse Energy (mJ)	40
Center Wavelength (nm)	1064
Fibre Length (m)	Up to 30 m

Handheld Scanner

Minimum Spot Diameter (mm, 1/e2)	1.2
Scan Rate (m/sec)	Max. 10
Scan Width (mm)	Max. 60

Facility Requirements

Supply Voltage	220 V ± 10% Single-Phase
Supply Frequency	50 or 60 Hz
Nominal Power Consumption	4 kVA
Environmental Conditions	Temp 15 - 35°C air cooled

All specifications are preliminary and subject to change without notice

Dimensions

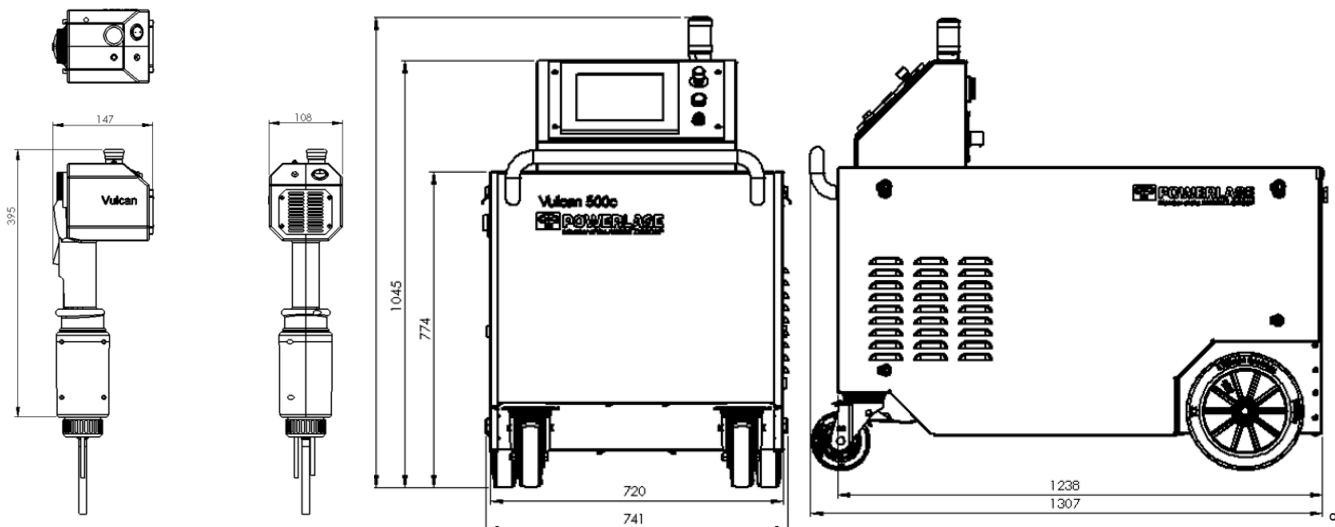

LASER RADIATION
AVOID EYE OR SKIN EXPOSURE TO
DIRECT OR SCATTERED RADIATION
CLASS 4 LASER PRODUCT

ANDRITZ Powerlase Ltd may make improvements and/or changes in the products described herein at any time without notice.

Doc No: 069-0073-8